

IS205X3,2,1  
IS205-3,2,1



**LOW INPUT CURRENT NON-BASE  
LEAD PHOTOTRANSISTOR  
OPTICALLY COUPLED ISOLATOR**

**APPROVALS**

- UL recognised, File No. E91231
- 'X' SPECIFICATION APPROVALS
  - VDE 0884 in 3 available lead forms : -
    - STD
    - G form
    - SMD approved to CECC 00802
  - Certified to EN60950 by the following Test Bodies :-
    - Nemko - Certificate No. P96101299
    - Fimko - Registration No. 190469-01..22
    - Semko - Reference No. 9620076 01
    - Demko - Reference No. 305567

**DESCRIPTION**

The IS205-3, -2, -1 series of optically coupled isolators consist of infrared light emitting diode and NPN silicon photo transistor in a standard 6 pin dual in line plastic package with the base pin unconnected.

**FEATURES**

- Options :-
  - 10mm lead spread - add G after part no.
  - Surface mount - add SM after part no.
  - Tape&reel - add SMT&R after part no.
- Low input current 0.5mA  $I_F$
- High Current Transfer Ratio (50% min)
- High Isolation Voltage (5.3kV<sub>RMS</sub>, 7.5kV<sub>PK</sub>)
- Basepin unconnected for improved noise immunity in high EMI environment

**APPLICATIONS**

- DC motor controllers
- Industrial systems controllers
- Signal transmission between systems of different potentials and impedances

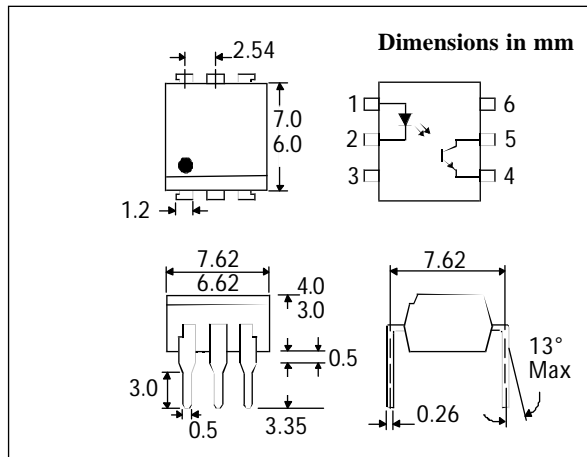
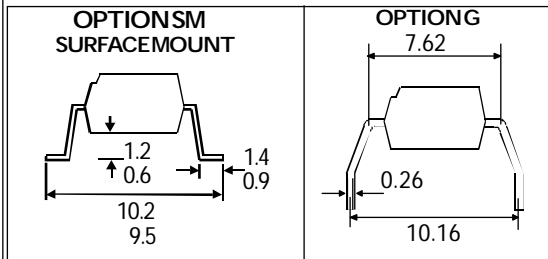

**ABSOLUTE MAXIMUM RATINGS  
(25°C unless otherwise specified)**

Storage Temperature	_____	-55°C to + 150°C
Operating Temperature	_____	-55°C to + 100°C
Lead Soldering Temperature	(1/16 inch (1.6mm) from case for 10 secs)	260°C

**INPUT DIODE**

Forward Current	_____	60mA
Reverse Voltage	_____	10V
Power Dissipation	_____	105mW

**OUTPUT TRANSISTOR**

Collector-emitter Voltage $BV_{CEO}$	_____	70V
Emitter-collector Voltage $BV_{ECO}$	_____	6V
Power Dissipation	_____	160mW

**POWER DISSIPATION**

Total Power Dissipation	_____	200mW
(derate linearly 2.67mW/°C above 25°C)		

**ISOCOM COMPONENTS LTD**  
Unit 25B, Park View Road West,  
Park View Industrial Estate, Brenda Road  
Hartlepool, Cleveland, TS25 1YD  
Tel: (01429) 863609 Fax :(01429) 863581



**ELECTRICAL CHARACTERISTICS (  $T_A = 25^\circ\text{C}$  Unless otherwise noted )**

PARAMETER		MIN	TYP	MAX	UNITS	TEST CONDITION
Input	Forward Voltage ( $V_F$ )		1.2	1.4	V	$I_F = 20\text{mA}$
	Reverse Voltage ( $V_R$ )	10			V	$I_R = 10\mu\text{A}$
	Reverse Current ( $I_R$ )			10	$\mu\text{A}$	$V_R = 10\text{V}$
Output	Collector-emitter Breakdown ( $BV_{CEO}$ ) ( Note 2 )	70			V	$I_C = 1\text{mA}$
	Emitter-collector Breakdown ( $BV_{ECO}$ )	6			V	$I_E = 100\mu\text{A}$
	Collector-emitter Dark Current ( $I_{CEO}$ )			50	nA	$V_{CE} = 10\text{V}$
Coupled	Current Transfer Ratio (CTR) (Note 2)					
	IS205-3	70			%	$0.5\text{mA } I_F, 0.4\text{V } V_{CE}$
		100			%	$1.0\text{mA } I_F, 0.4\text{V } V_{CE}$
	IS205-2	50			%	$0.5\text{mA } I_F, 0.4\text{V } V_{CE}$
	IS205-1	50			%	$1.0\text{mA } I_F, 0.4\text{V } V_{CE}$
	Collector-emitter Saturation Voltage -3			0.4	V	$0.5\text{mA } I_F, 0.35\text{mA } I_C$
	-2			0.4	V	$0.5\text{mA } I_F, 0.25\text{mA } I_C$
	-1			0.4	V	$1.0\text{mA } I_F, 0.5\text{mA } I_C$
	Input to Output Isolation Voltage $V_{ISO}$	5300			$V_{RMS}$	See note 1
		7500			$V_{PK}$	See note 1
Input-output Isolation Resistance $R_{ISO}$	$5 \times 10^{10}$			$\Omega$	$V_{IO} = 500\text{V}$ (note 1)	
Output Rise Time tr		4	18	$\mu\text{s}$	$V_{CE} = 2\text{V}$ ,	
Output Fall Time tf		3	18	$\mu\text{s}$	$I_C = 0.2\text{mA}, R_L = 100\Omega$	

Note 1 Measured with input leads shorted together and output leads shorted together.

Note 2 Special Selections are available on request. Please consult the factory.

**Collector Power Dissipation vs. Ambient Temperature**

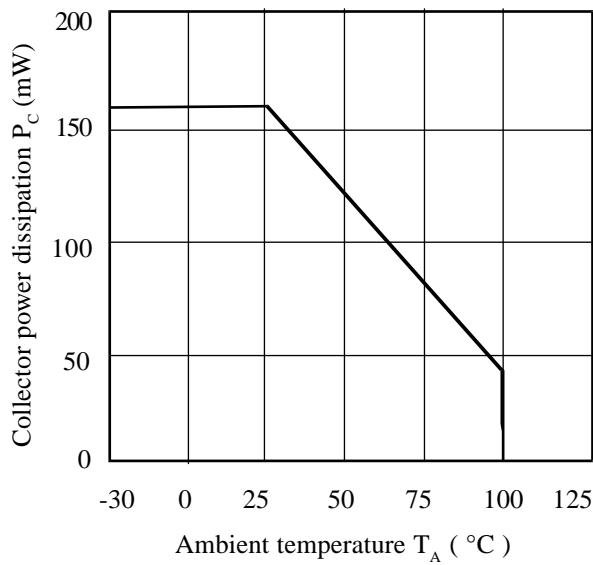

**Collector Current vs. Low Collector-emitter Voltage**

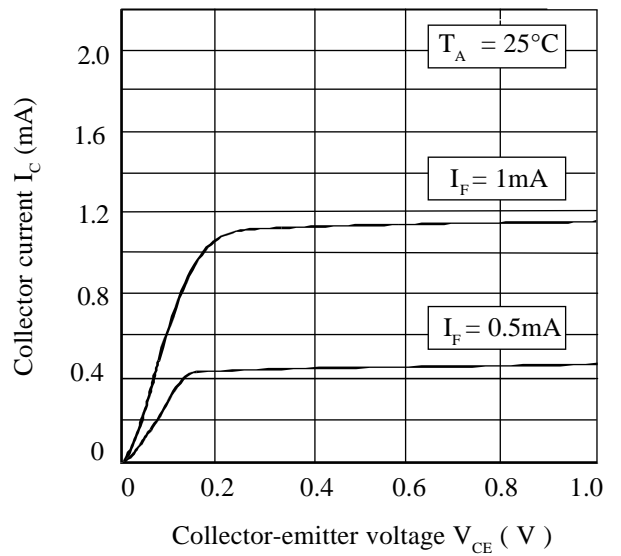

**Forward Current vs. Ambient Temperature**

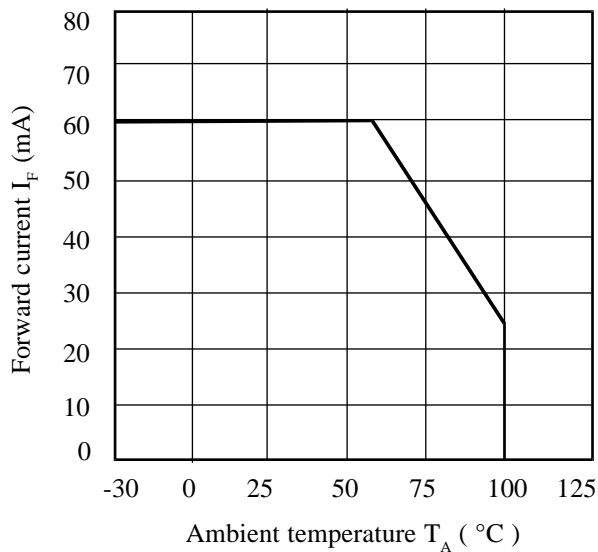

**Relative Current Transfer Ratio vs. Ambient Temperature**

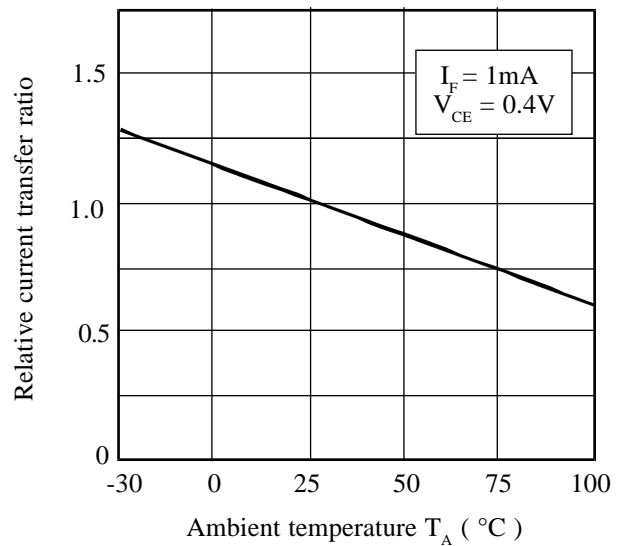

**Collector-emitter Saturation Voltage vs. Ambient Temperature**

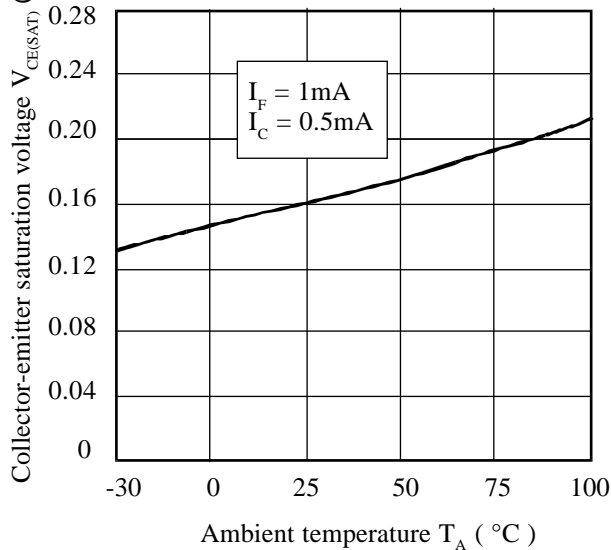

**Current Transfer Ratio vs. Forward Current**

